

# WALKIN SHOWER SCREEN INSTALLATION INSTRUCTION

316034-WR-BG/MB

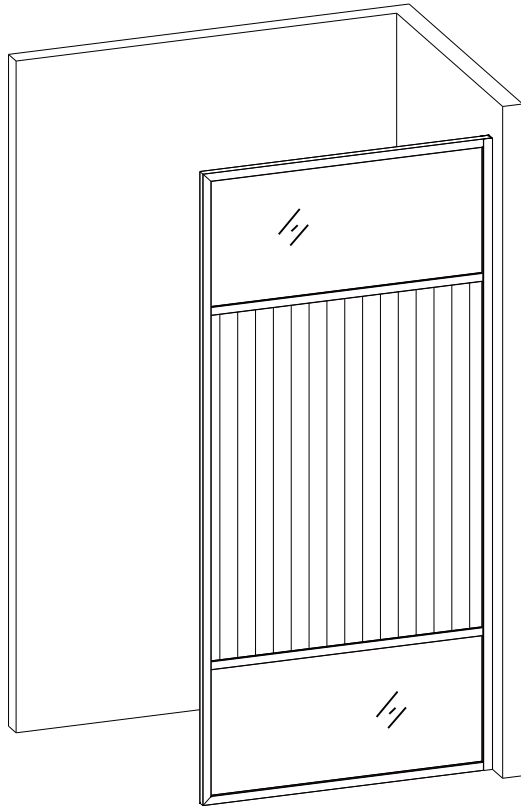

**IMPORTANT-**Please read and follow all warnings and instructions before using this product. Injury can result from improper use. Save this documents.

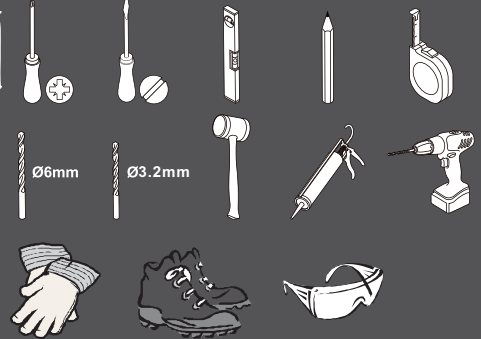

**WARNING**  
Tempered Glass, please don't hit the corners and the surrounding, otherwise the glass will burst.

## ● General Information

Please inspect the product immediately upon receipt for transit damage, missing packs/parts or manufacturing fault. Damage reported later cannot be accepted. Please handle the product with care avoiding knocks and shock loading to all sides and edges of the glass.

### Notes: Safety glass can not be re-worked.

Please read these instructions carefully before start of installation.

Special care should be taken when drilling walls to avoid hidden pipes or electrical cables.

Note: This product is heavy and may require two people to install.

## Aftercare instructions

After use, your shower should be cleaned with soap and water. This is particularly important in hard water districts where insoluble lime salts may be deposited and allowed to build up. Cleaners of a gritty or abrasive nature should not be used. Care should be taken to avoid contact with strong chemicals such as organic solvents and strippers.

Glass cleaners can be used but with caution, if in doubt contact the manufacturer of the cleaner in question.

Please keep these instructions for aftercare and customer service details.

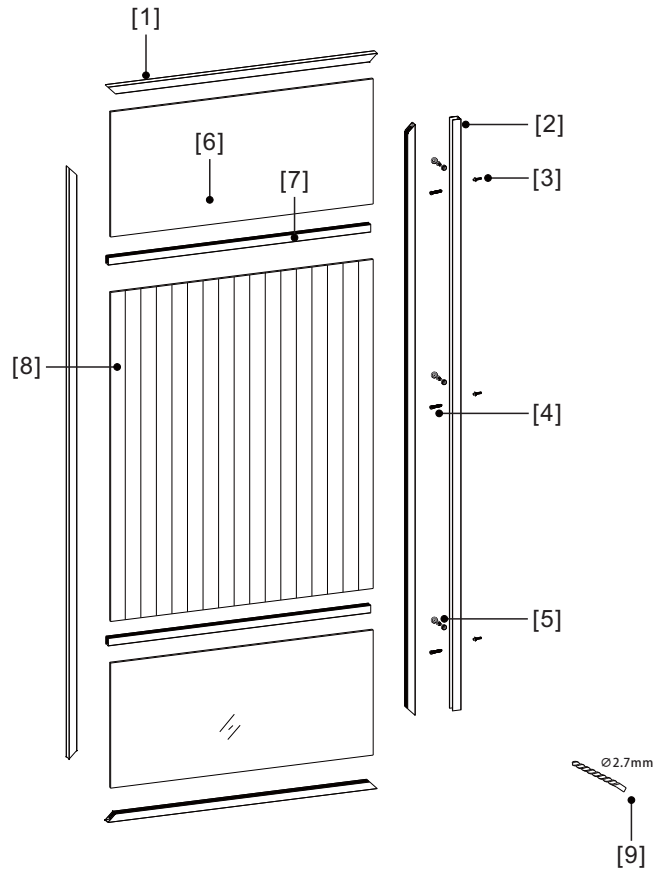

- [1] 4X Aluminium Profile
- [2] 1X Wall Profile
- [3] 3X Wall Anchor
- [4] 3X Screw ST4X30
- [5] 3X Screw Cap+Screw ST3,5X10
- [6] 2X Fixed Glass
- [7] 2X Divide Strip
- [8] 1X Changhong glass
- [9] 1X Drill bits



● Box Contents:

[1]	4X Aluminium Profile	➔	
[2]	1X Wall Profile	➔	
[3]	3X Wall Anchor	➔	
[4]	3X Screw ST4X30	➔	
[5]	3X Screw Cap Screw ST3,5X10	➔	
[6]	2X Fixed Glass	➔	
[7]	2X Divide Strip	➔	
[8]	1X Changhong glass	➔	
[9]	1X Drill bits	➔	





● Assembly

01

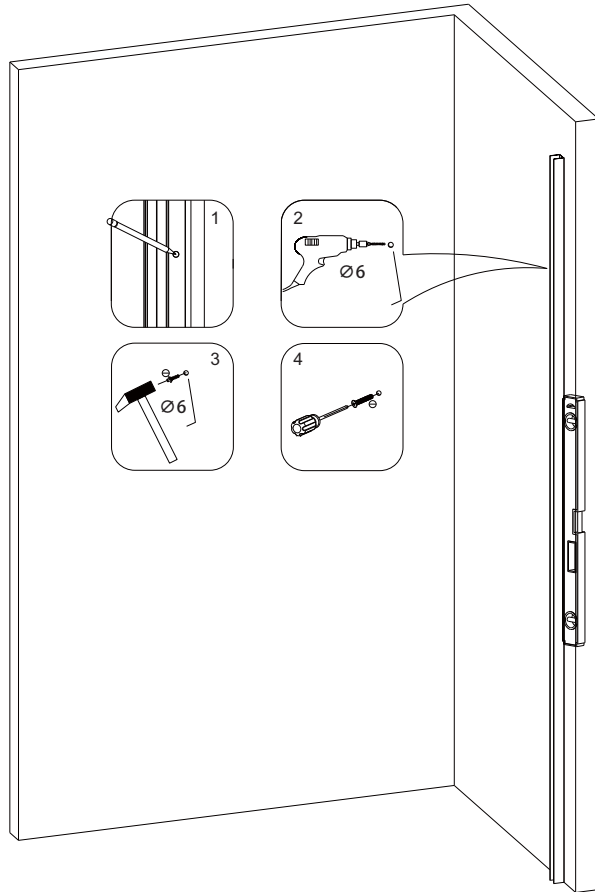
[2]	 1X
[3]	 3X
[4]	 3X ST4X30



02

[5]	 3X
[9]	 Ø2.7mm 1X

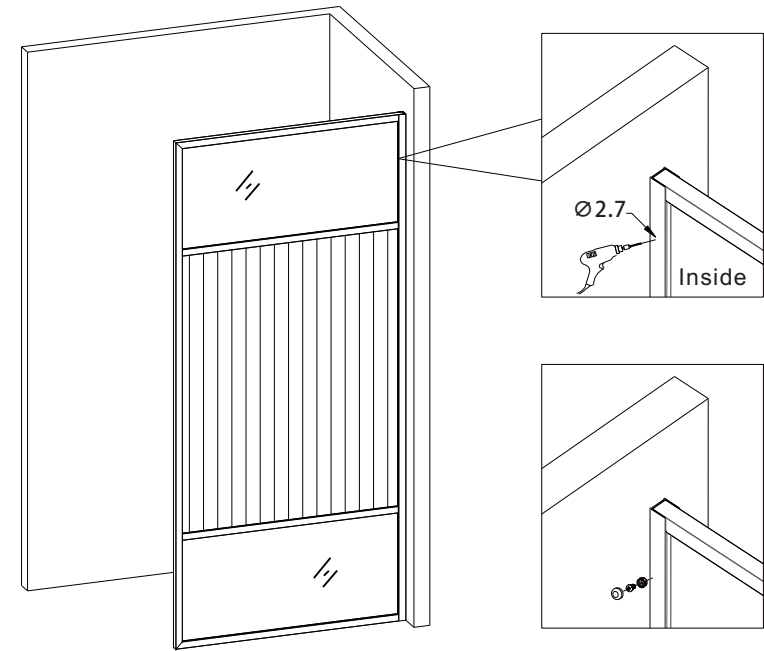
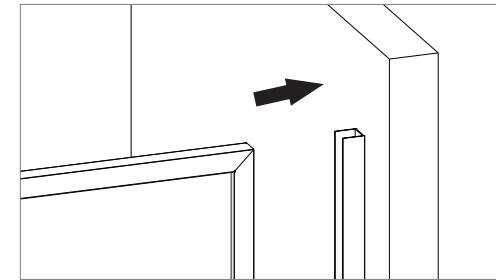

03

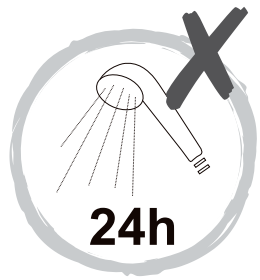

04

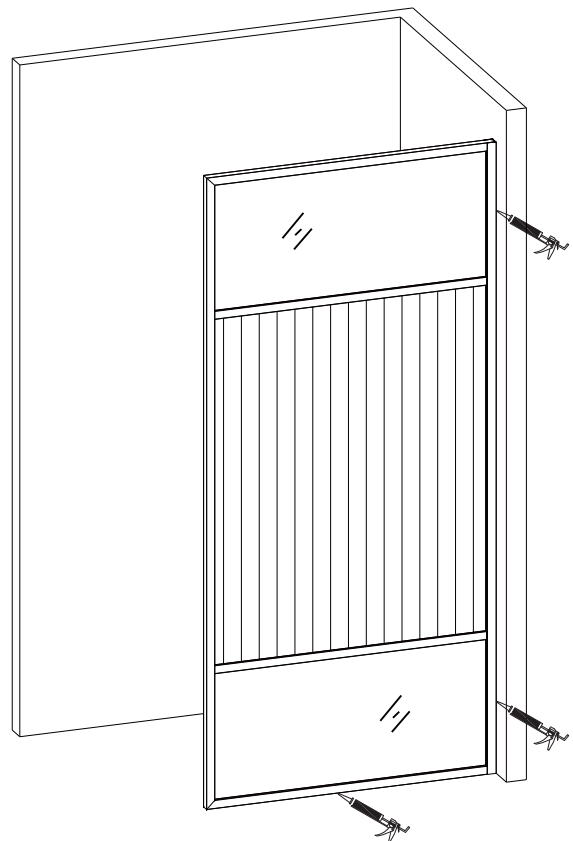

 Please ensure the bottom horizontal is straight before the silicone sealant to cure fully

- Do not use the shower enclosure for at least 24 hour in order to allow the silicone sealant to cure fully.